

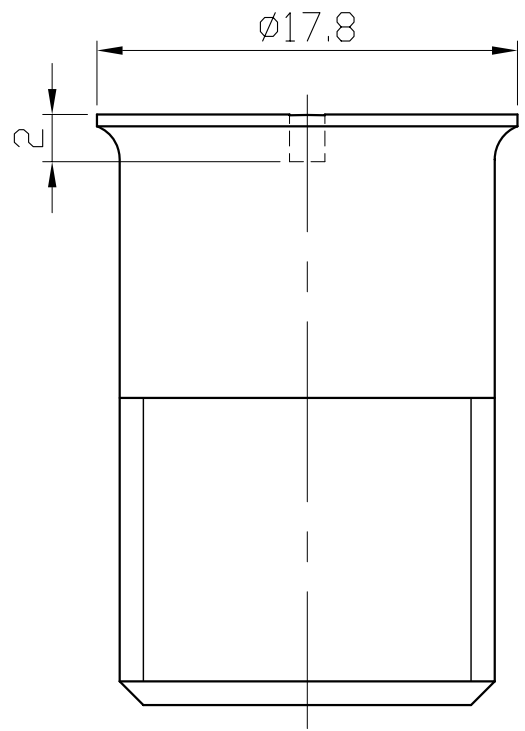

1 2 3 4 5 6 7 8 9 10 11 12 13 14 15 16 17 18 19 20

A
B
C
D
E
F
G
H
I
J
K
L
M
N
O
P
Q
R
S
T
U
V
W
X
Y
Z
AA
AB
AC

A
B
C
D
E
F
G
H
I
J
K
L
M
N
O
P
Q
R
S
T
U
V
W
X
Y
Z
AA
AB
AC

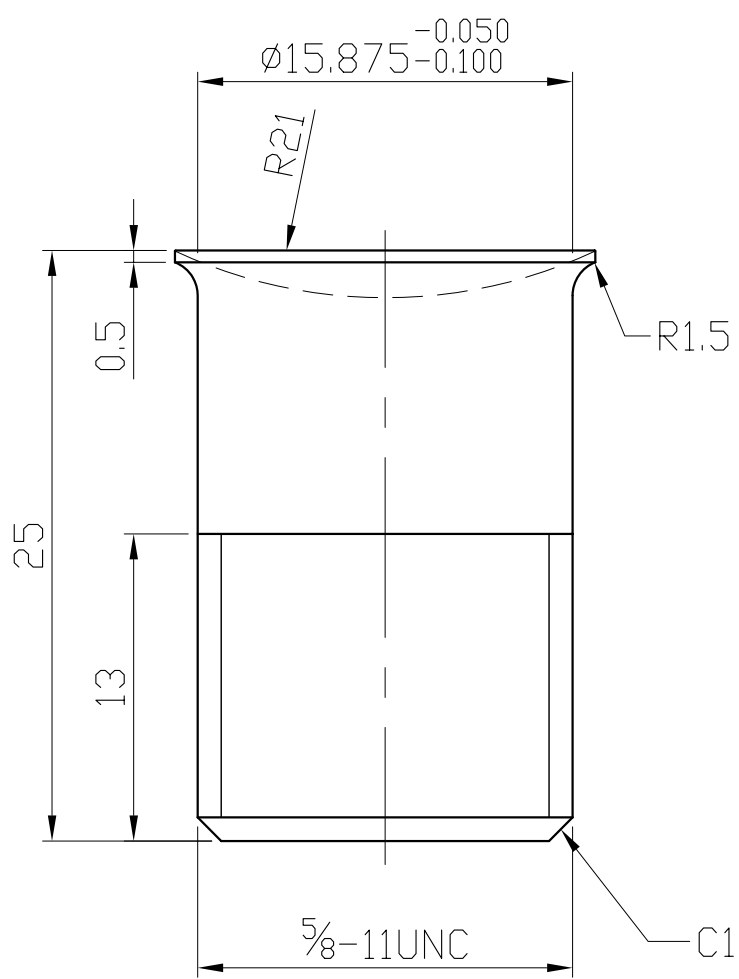
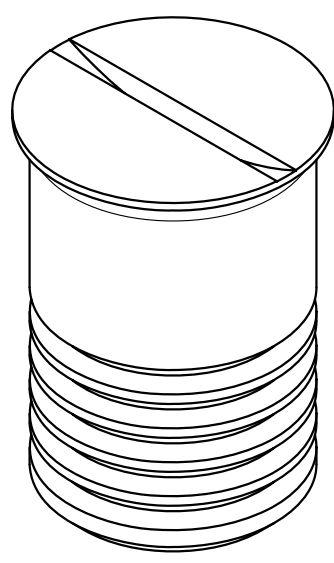
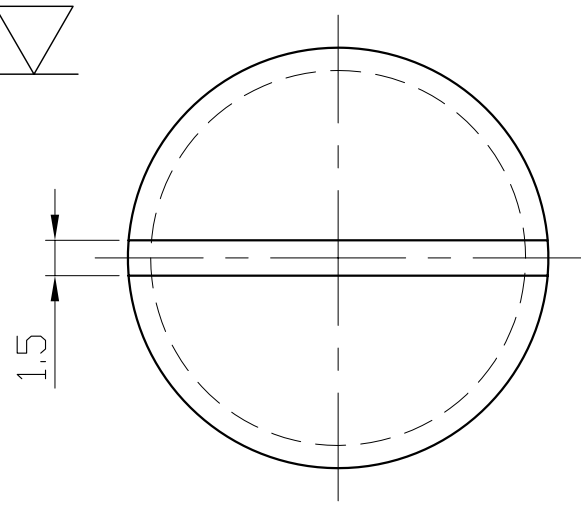
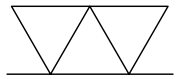

Material AISI1144		Heat treatment			Surface treatment Black Oxide			
Drafted by S.C.H	Checked by	Approved by	Scale 1/1	Date 2010.09.24	Sheet 1/1	Edition A		
 LEAVE INDUSTRIAL CO., LTD.			TITLE PROTECTION PLUG					
			DWG. NO. 10-PT34-05					

1 2 3 4 5 6 7 8 9 10 11 12 13 14 15 16 17 18 19 20